

normann

C O P E N H A G E N

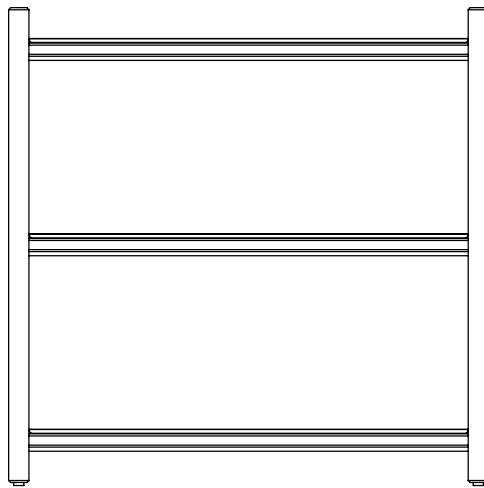

WORK

BOOKCASE LOW 4 PILAR

ASSEMBLY

INSTRUCTIONS

OVERVIEW

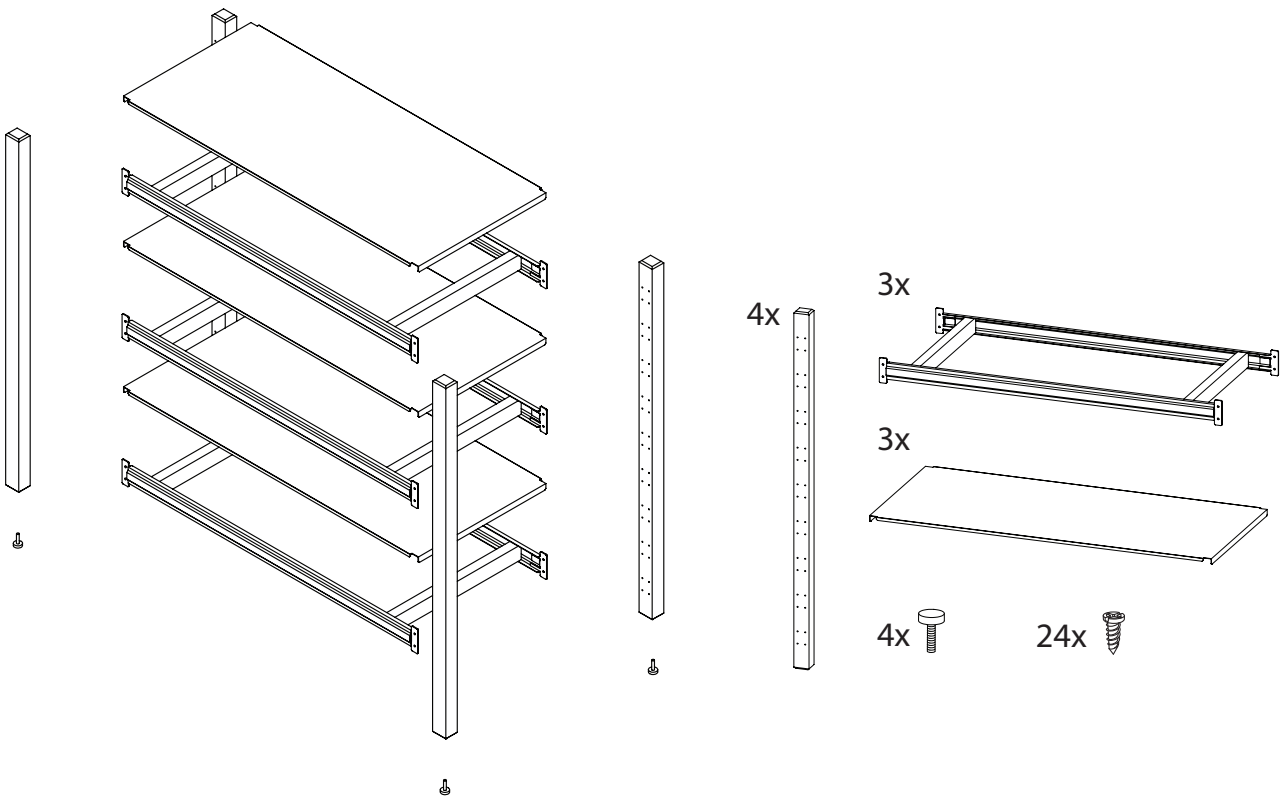

normann

C O P E N H A G E N

WORK BOOKCASE LOW 4 PILAR - ASSEMBLY MANUAL

1

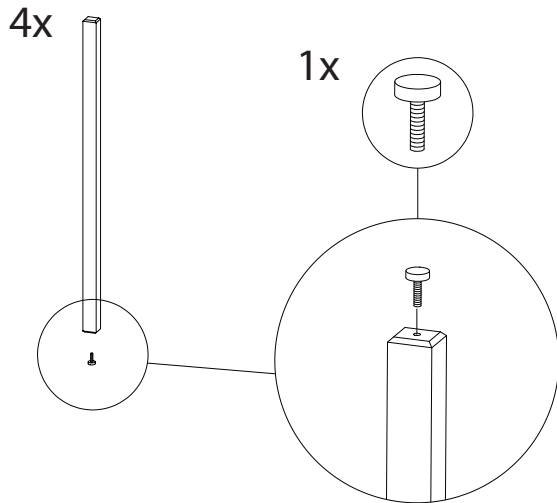

2

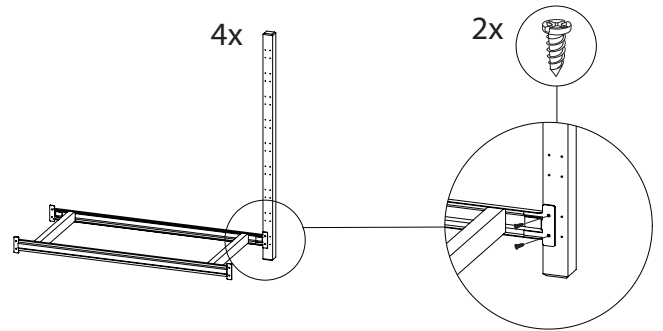

3

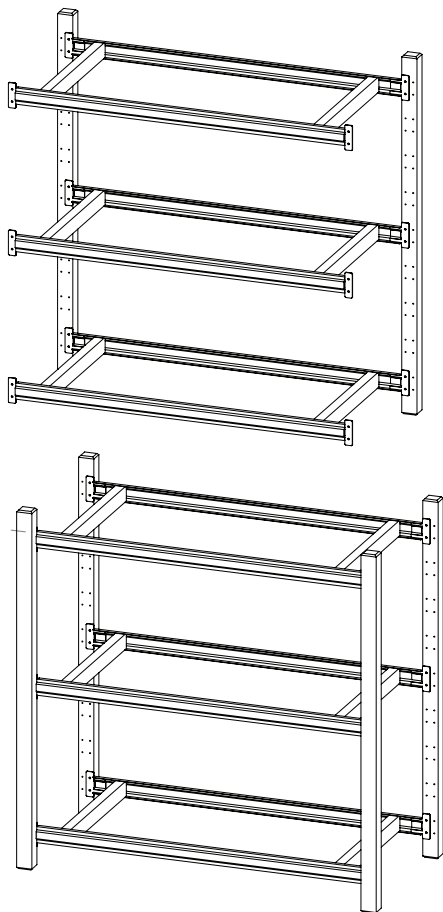

4

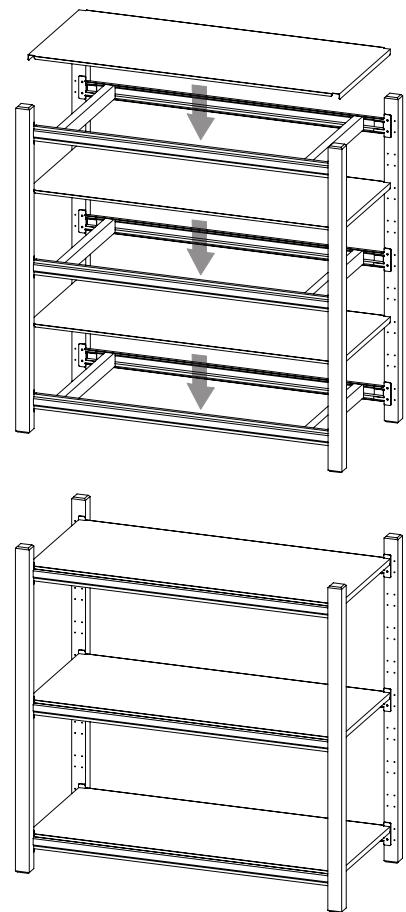

normann

C O P E N H A G E N

Normann Copenhagen · Østerbrogade 70
2100 Copenhagen Ø · Denmark · Tlf. +45 35 55 44 59
normann-copenhagen.com · normann@normann-copenhagen.com