

# normann

C O P E N H A G E N

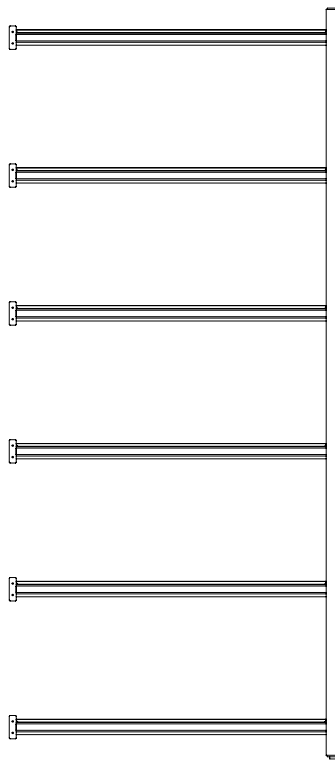

# WORK

BOOKCASE HIGH 2 PILAR

# ASSEMBLY INSTRUCTIONS

# OVERVIEW

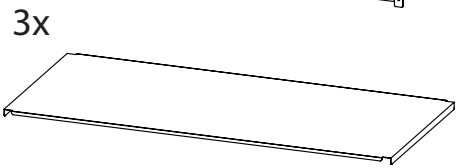
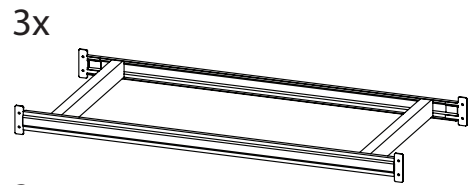
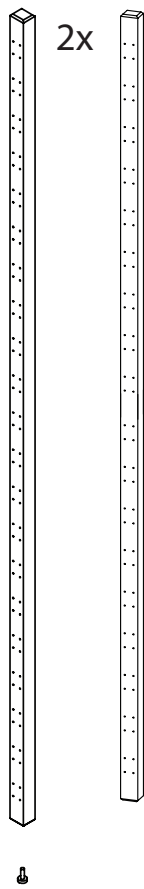
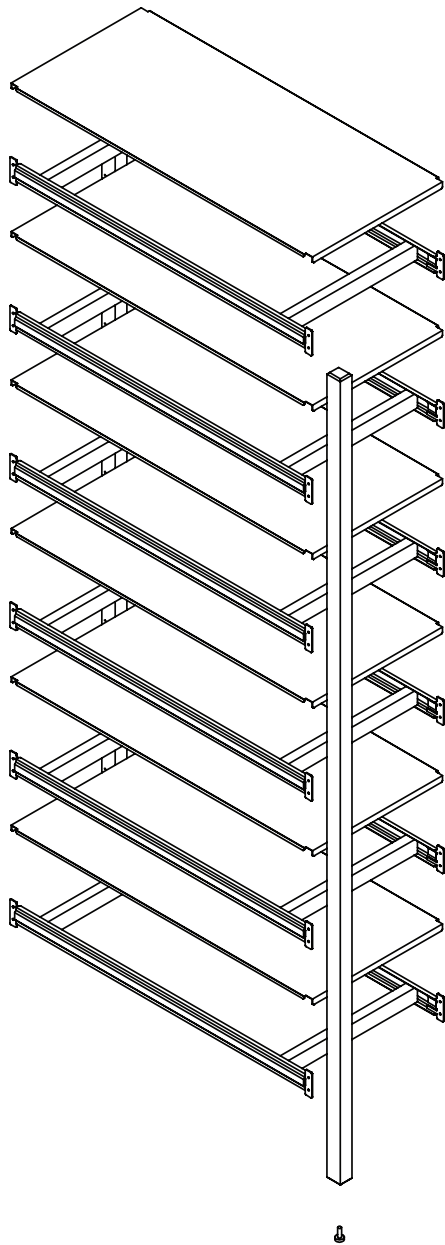

**normann**

COPENHAGEN

**WORK BOOKCASE HIGH 2 PILAR - ASSEMBLY MANUAL**

**1**

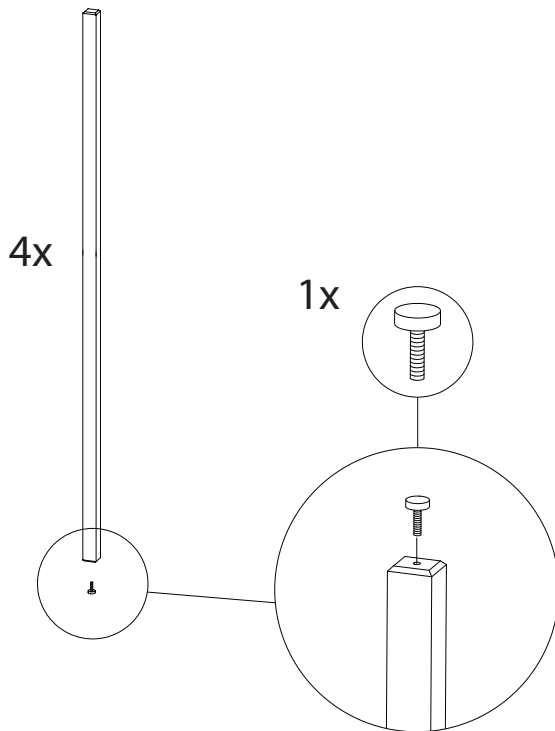

**2**

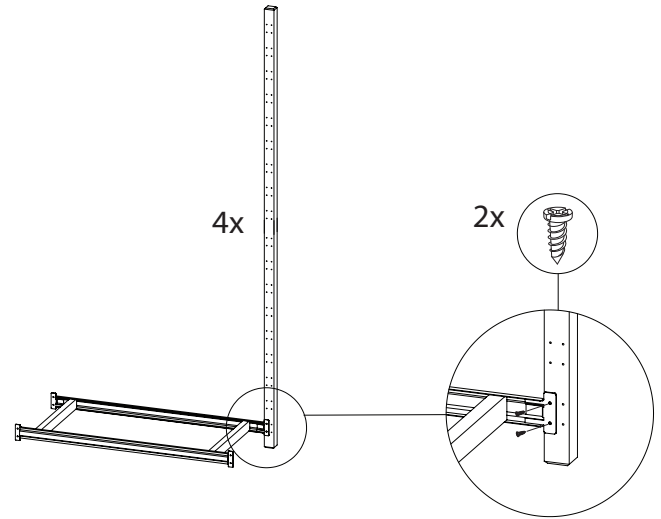

**3**

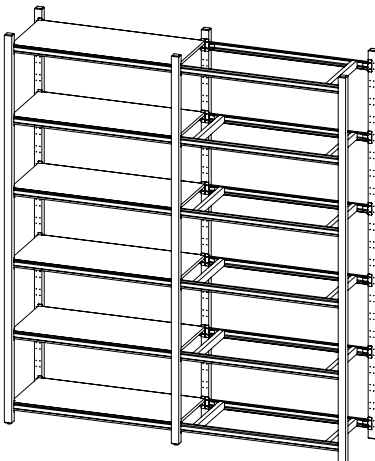
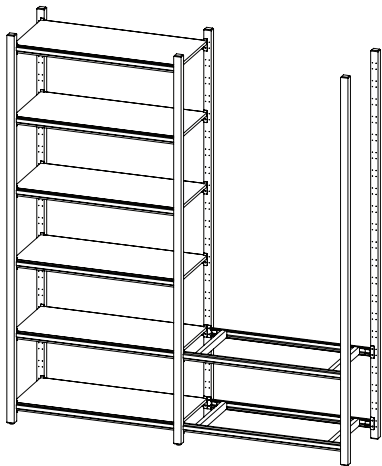

**4**

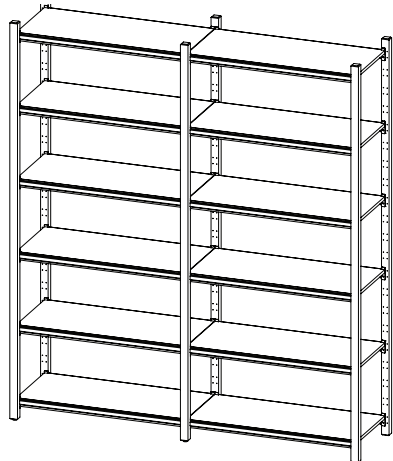
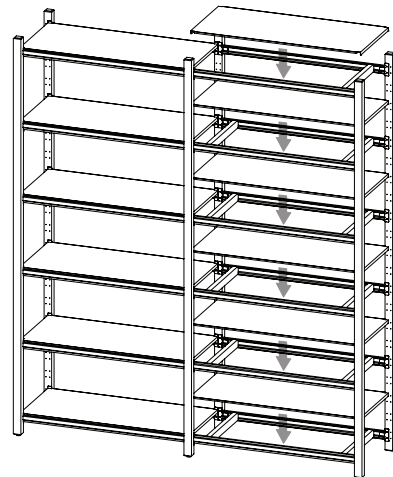

**normann**

**C O P E N H A G E N**

Normann Copenhagen · Østerbrogade 70  
2100 Copenhagen Ø · Denmark · Tlf. +45 35 55 44 59  
normann-copenhagen.com · normann@normann-copenhagen.com